

Información tubería SmartPipe+, SmartPipe+HP y SmartPipeXL

Índice

1. Tubos.
2. Accesorios.
 - 2.1 SmartPipe+ y SmartPipe+HP.
 - 2.2 SmartPipeXL.
3. Datos técnicos.
4. Explosionado accesorio SmartPipe+ y SmartPipe+HP: 20 mm a 90 mm.
5. Explosionado accesorio SmartPipe+: 110 mm y 160 mm.
6. Explosionado accesorio SmartPipeXL.
7. Herramienta.
8. Dimensiones de la tuerca.
9. Instrucciones de ensamble: 20 mm a 90 mm.
 - 9.1 Preparación del tubo.
 - 9.2 Ensamble.
10. Instrucciones de ensamble: 110 mm y 160 mm.
 - 10.1 Preparación del tubo.
 - 10.2 Ensamble.

Índice

- 11. Instrucciones de ensamble: 200 mm.
 - 11.1 Preparación del tubo.
 - 11.2 Ensamble.
- 12. Para tener en cuenta.
- 13. Explosionado y ensamble 20 mm a 90 mm.
- 14. Explosionado y ensamble 110 mm y 160 mm.
- 15. Explosionado y ensamble 200 mm.
- 16. Detalle de los ensambles.
- 17. Derivaciones y Puntos de uso SmartPipe+.
- 18. Derivaciones y Puntos de uso SmartPipeXL.
- 19. Diámetro de broca barril para las derivaciones.
- 20. Ensamble de las derivaciones.
- 21. Puntos de uso con derivaciones.
- 22. Ensamble de los collarines.
- 23. Puntos de uso con collarines SmartPipe+.
- 24. Puntos de uso con collarines SmartPipeXL: Collarín 200 mm x 50 mm.

Índice

- 25. Puntos de uso con collarines SmartPipeXL: Collarín 200 mm x 25 mm.
- 26. Puntos de uso con collarines SmartPipeXL: Collarín 200 mm x 3/4" NPT.
- 27. Tapones.
 - 27.1 Ensamble
 - 27.2 Desensamble
- 28. Abrazaderas

Ejemplos de instalaciones KAESER: SmartPipe+, SmartPipe+HP y SmartPipeXL.

1. Tubos

- SmartPipe+

- ✓ Ø 160 mm.
- ✓ Ø 110 mm.
- ✓ Ø 90 mm.
- ✓ Ø 75 mm.
- ✓ Ø 63 mm.
- ✓ Ø 50 mm.
- ✓ Ø 40 mm.
- ✓ Ø 32 mm.
- ✓ Ø 25 mm.
- ✓ Ø 20 mm.

- SmartPipe+HP

- ✓ Ø 63 mm.
- ✓ Ø 50 mm.
- ✓ Ø 40 mm.
- ✓ Ø 32 mm.
- ✓ Ø 25 mm.
- ✓ Ø 20 mm.

- SmartPipeXL

- ✓ Ø 200 mm.



2. Accesorios

SmartPipe+, SmartPipe+HP y SmartPipeXL



2.1 SmartPipe+ y SmartPipe+HP

				
Tubo	Tee	Válvula tubo-tubo	Reducción tubo-tubo	Tapón con purga
				
Cople	Codo roscado	Válvula tubo-NPT	Derivación	Distribuidor 4P
				
Codo 90°	Tee roscada	Recto macho	Collarín	Abrazadera
				
Codo 45°	Válvula de latón H-H	Recto hembra	Tapón	Manguera

2.2 SmartPipeXL

 <p>Cople</p>	 <p>Tee reducción</p>	 <p>Collarín</p>	 <p>Collarín a 90°</p>
 <p>Codo 90°</p>	 <p>Collarín FNPT</p>	 <p>Válvula de mariposa</p>	 <p>Reducción tubo-tubo</p>
 <p>Tee</p>	 <p>Tapón</p>	 <p>Brida</p>	 <p>Abrazadera</p>

3. Datos técnicos

- SmartPipe+

RAL 5012

Presión de trabajo 16 bar

Temperatura de trabajo -20 °C a 100 °C

- SmartPipeXL

RAL 5012

Presión de trabajo 13 bar

Temperatura de trabajo -20 °C a 80 °C

- SmartPipe+HP

RAL 5017

Presión de trabajo 70 bar

Temperatura de trabajo -20 °C a 100 °C

Diámetro (mm)	Diámetro externo (mm)	Espesor de pared (mm)	Longitud (m)	Peso (kg)
20	20	1.0	4	0.80
25	25	1.1	6	1.67
32	32	1.2	6	2.46
40	40	1.3	6	3.54
50	50	1.5	6	3.96
63	63	1.8	6	5.94
75	75	2	6	7.86
90	90	2.4	6	11.04
110	110	3.0	6	16.68
160	160	4.3	6	34.92
200	205	3.6	5.8	34.80

Diámetro HP (mm)	Diámetro externo (mm)	Espesor de pared (mm)	Longitud (m)	Peso (kg)
20	20	2.0	4	1.20
25	25	2.5	4	1.96
32	32	3	4	2.96
40	40	4	4	4.92
50	50	5	4	7.60
63	63	6	4	11.80

4. Explosionado accesorio SmartPipe+ y SmartPipe+HP

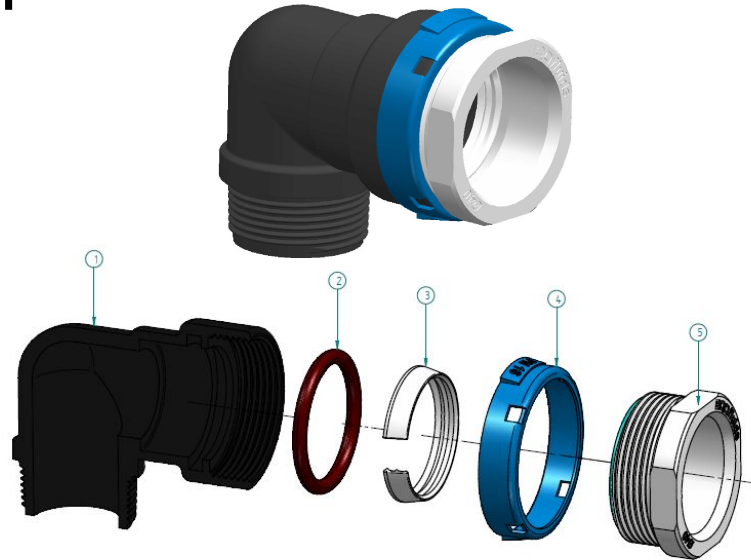

20 mm hasta 90 mm

- | | |
|---|--------------------------|
| 1 | Cuerpo |
| 2 | O-ring |
| 3 | Arandela de sujeción |
| 4 | Anillo de identificación |
| 5 | Tuerca |

5. Explosionado accesorio SmartPipe+

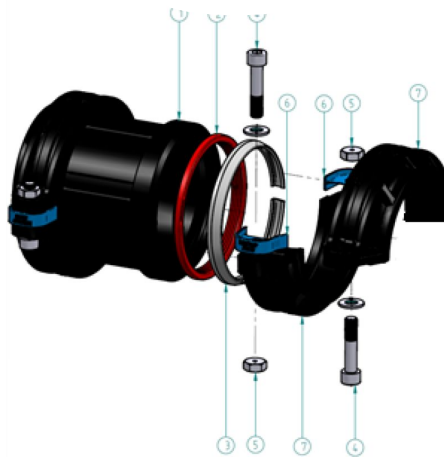
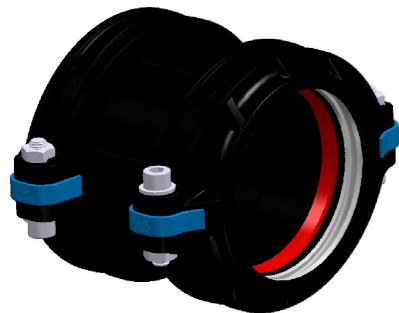

110 mm y 160 mm

1	Cuerpo
2	O-ring
3	Arandela de sujeción
4	Tornillo/arandela
5	Tuerca
6	Pieza de identificación
7	Arandela bipartida



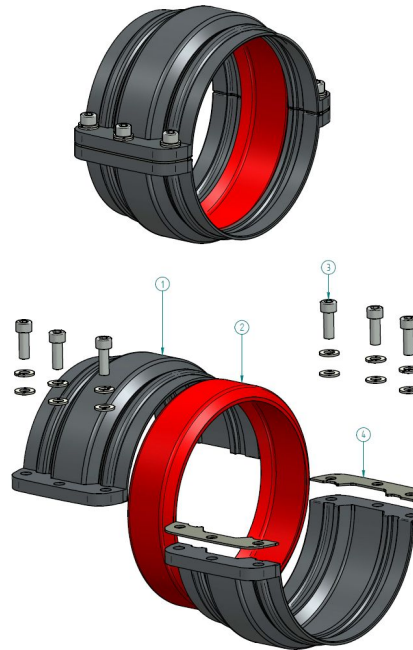









6. Explosionado accesorio SmartPipeXL





200 mm

- | | |
|---|------------------------|
| 1 | Cuerpo |
| 2 | Sello |
| 3 | Tornillo con arandelas |
| 4 | Separador plástico |

7. Herramienta

	20 mm - 75 mm	90 mm - 200 mm
Cortador de tubo	 	 
Removedor de rebaba		
Biselador		 
Taladro y corona		 
Lubricante jabón neutro con agua		
Marcador		

	20 mm - 75 mm	90 mm - 200 mm
Llaves allen 6 mm y 8 mm Llave de 17 mm		
Llave inglesa Llave plana		
Prensa hidráulica radial		

8. Dimensiones de la tuerca

Diámetro Tubo (mm)	Dimensión Tuerca (mm)
20	29
25	36
32	43
40	53
50	66
63	82
75	100
90	118

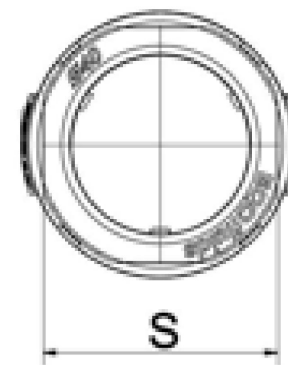
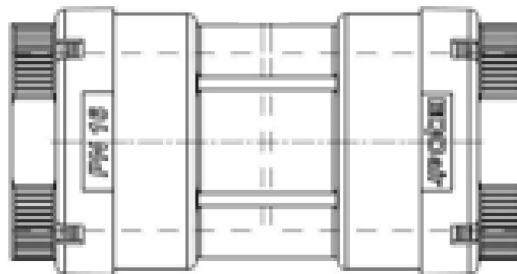

9. Instrucciones de ensamble: **20 mm a 90 mm**

9.1 Preparación del tubo

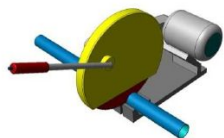

1. Realizar corte de la tubería a instalar.

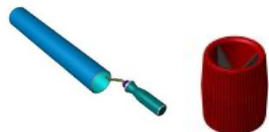

2. Quitar rebaba.



3. Realizar biselado.

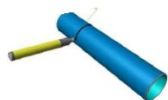

4. Realizar marcado en tubo de acuerdo a la siguiente tabla.

DN	20	25	32	40	50	63	90
l (mm)	35 (31)	37 (35)	46	56	68	83	93



5. Lubricar tubo.

9.2 Ensamble



1. Aflojar tuerca.



2. Insertar tubo.

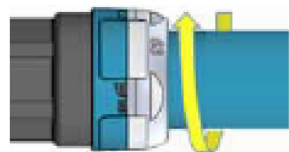

3. Apretar la tuerca a mano y dar un $\frac{1}{4}$ de vuelta al final con llave.

10. Instrucciones de ensamble: **110 mm y 160 mm**

10.1 Preparación del tubo

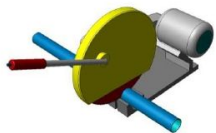

1. Realizar corte de la tubería a instalar.

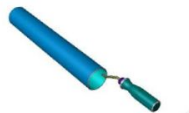

2. Quitar rebaba.



3. Realizar biselado.

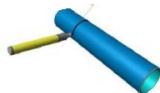

4. Realizar marcado en tubo de acuerdo a la siguiente tabla.

DN	110	160
l (mm)	70	134



5. Lubricar tubo.

10.2 Ensamble

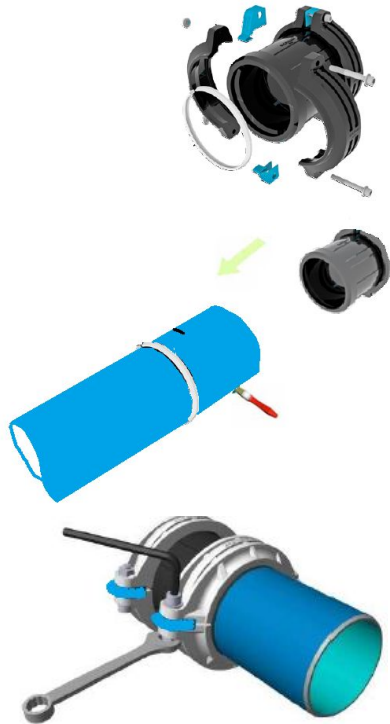

Torque 15 N/m

1. Desensamblar accesorio.
2. Colocar arandela de sujeción en tubo.
3. Insertar tubo en el accesorio.
4. Recorrer la arandela de sujeción a su posición.
5. Realizar el ensamble de la arandela bipartida.

Para diámetro 110 mm: hasta que exista contacto en las dos secciones.

Para diámetro 160 mm hasta observar una deformación en el plástico de identificación.

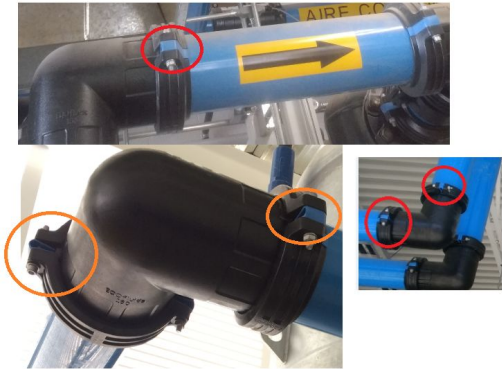

11. Instrucciones de ensamble: **200 mm**

11.1 Preparación del tubo

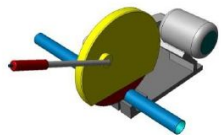

1. Realizar corte de la tubería a instalar.

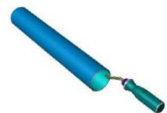

2. Quitar rebaba.



3. Realizar biselado.



4. Realizar reborde en el tubo de acuerdo a la siguiente tabla.

Número mínimo	DN200
De rebordes	12

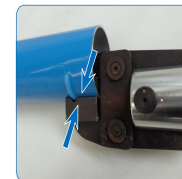
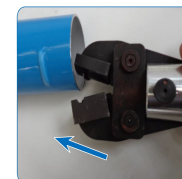

11.2 Ensamble

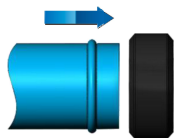

1. Deslizar el sello hacia el reborde del tubo.

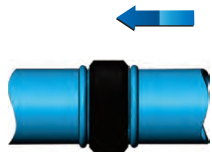

2. Insertar el segundo tubo.

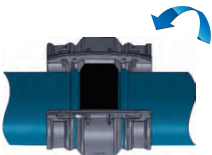

3. Posicionar el accesorio sobre el sello.

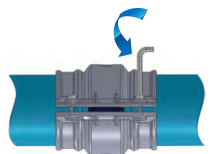

4. Apretar parcialmente con llave Allen.

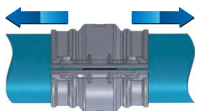

5. Jalar de los tubos hacia fuera del accesorio para completar la alineación.

11.2 Ensamble

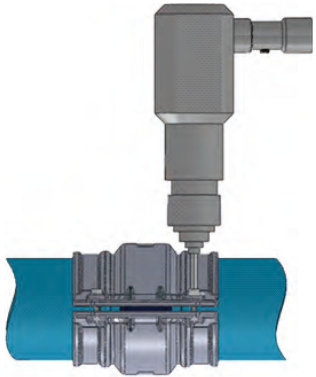

6. Realizar el apriete total de los tornillos.

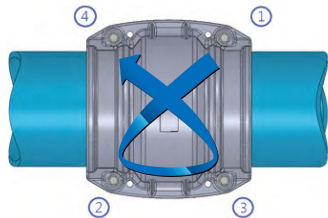

Para un ensamble efectivo, atornillar en patrón de "X".

Para desensamblar, realizar la misma actividad en orden inverso.

12. Para tener en cuenta...

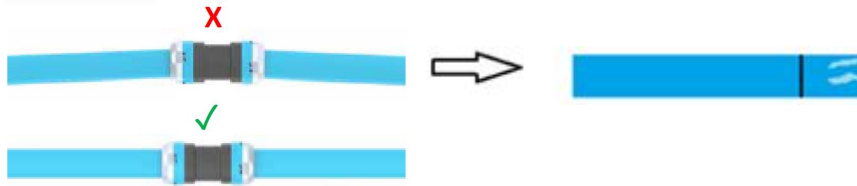

Realizar una correcta inserción de los tubos para evitar crear rayaduras sobre su superficie.



Sostener el tubo para realizar el apriete de los accesorios.



Ejemplo de un ensamble correcto.

13. Explosionado y ensamble 20 mm – 90 mm



14. Explosionado y ensamble 110 mm y 160 mm

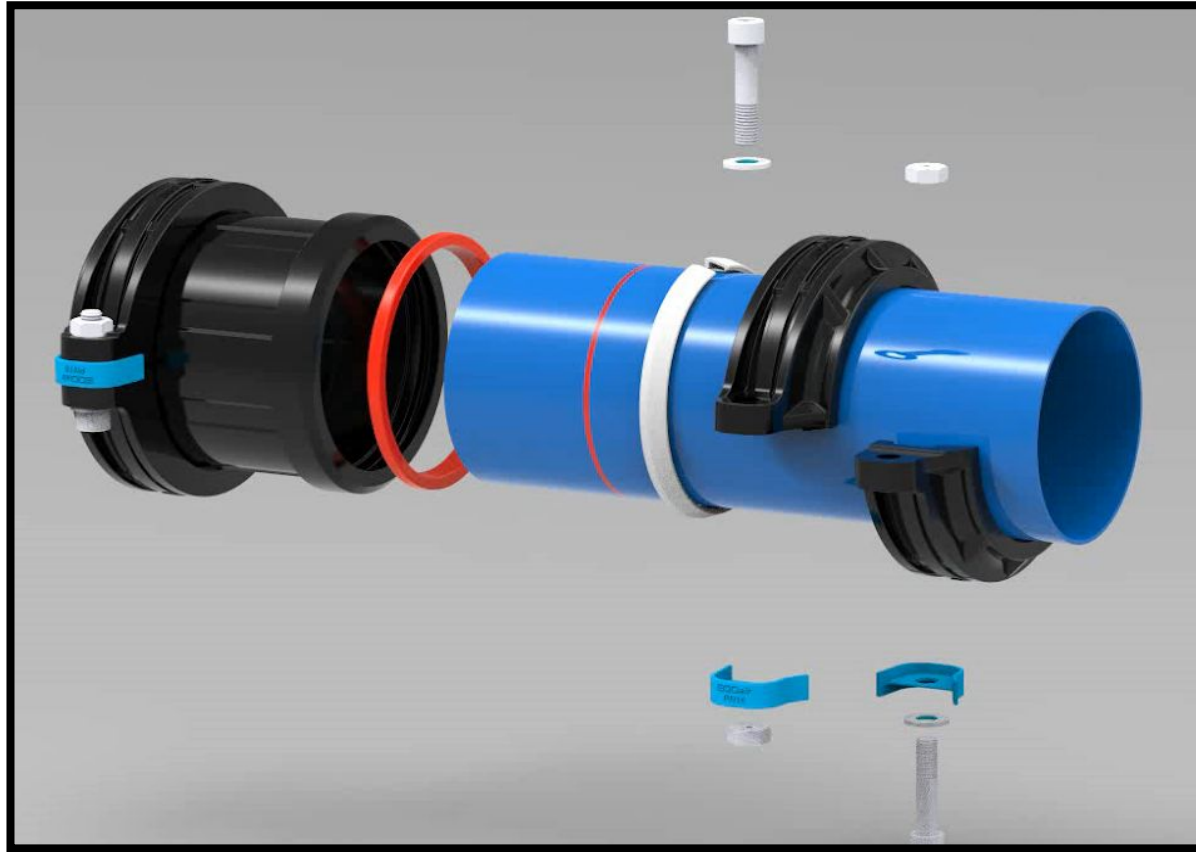

15. Explosionado y ensamble 200 mm

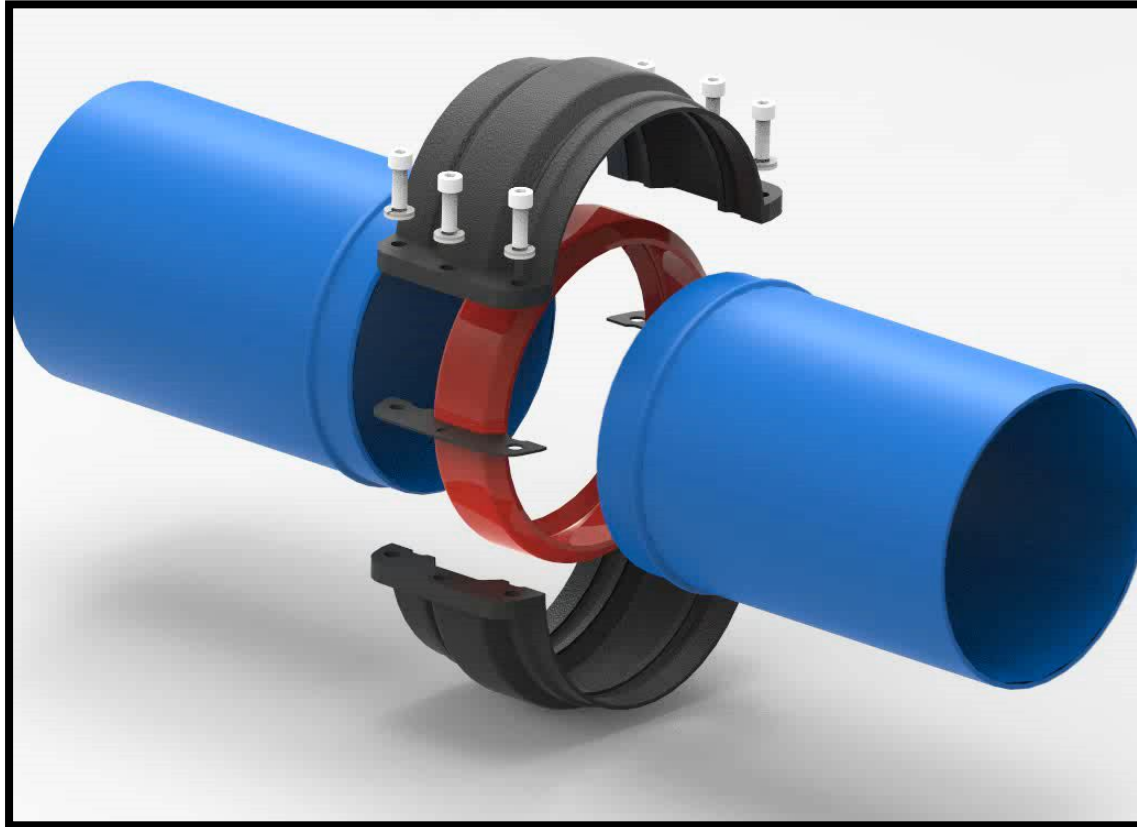

16. Detalle de los ensambles

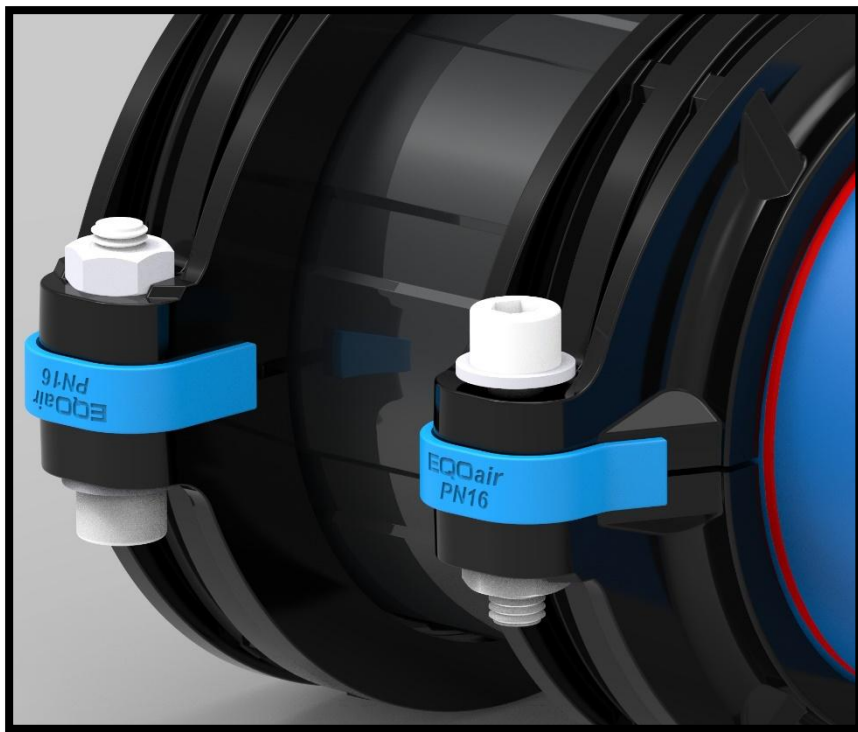

Ensamble de accesorios 110 mm

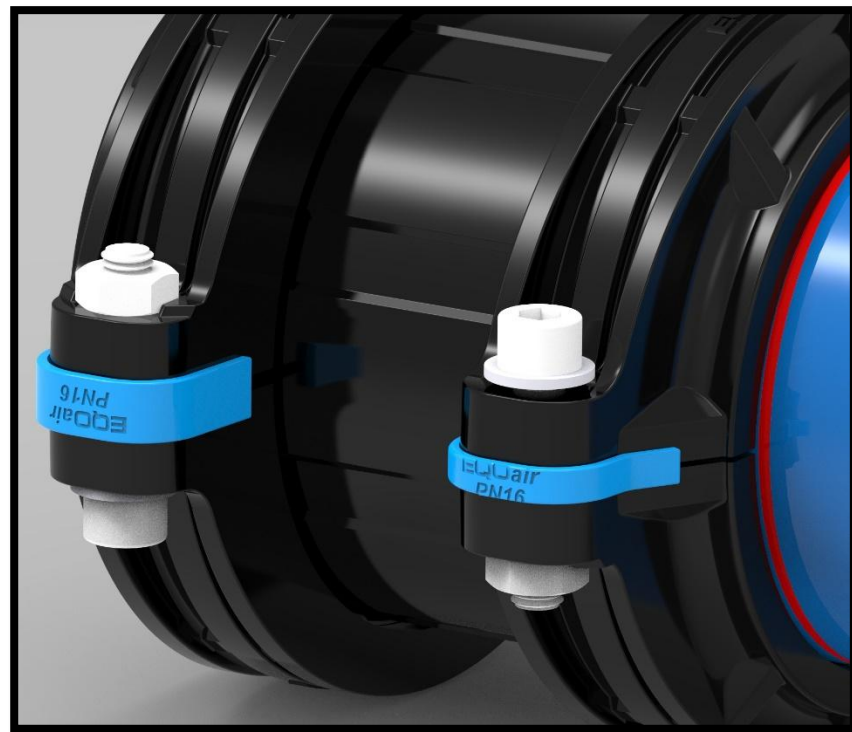

Ensamble de accesorios 160 mm

17. Derivaciones y Puntos de uso SmartPipe+

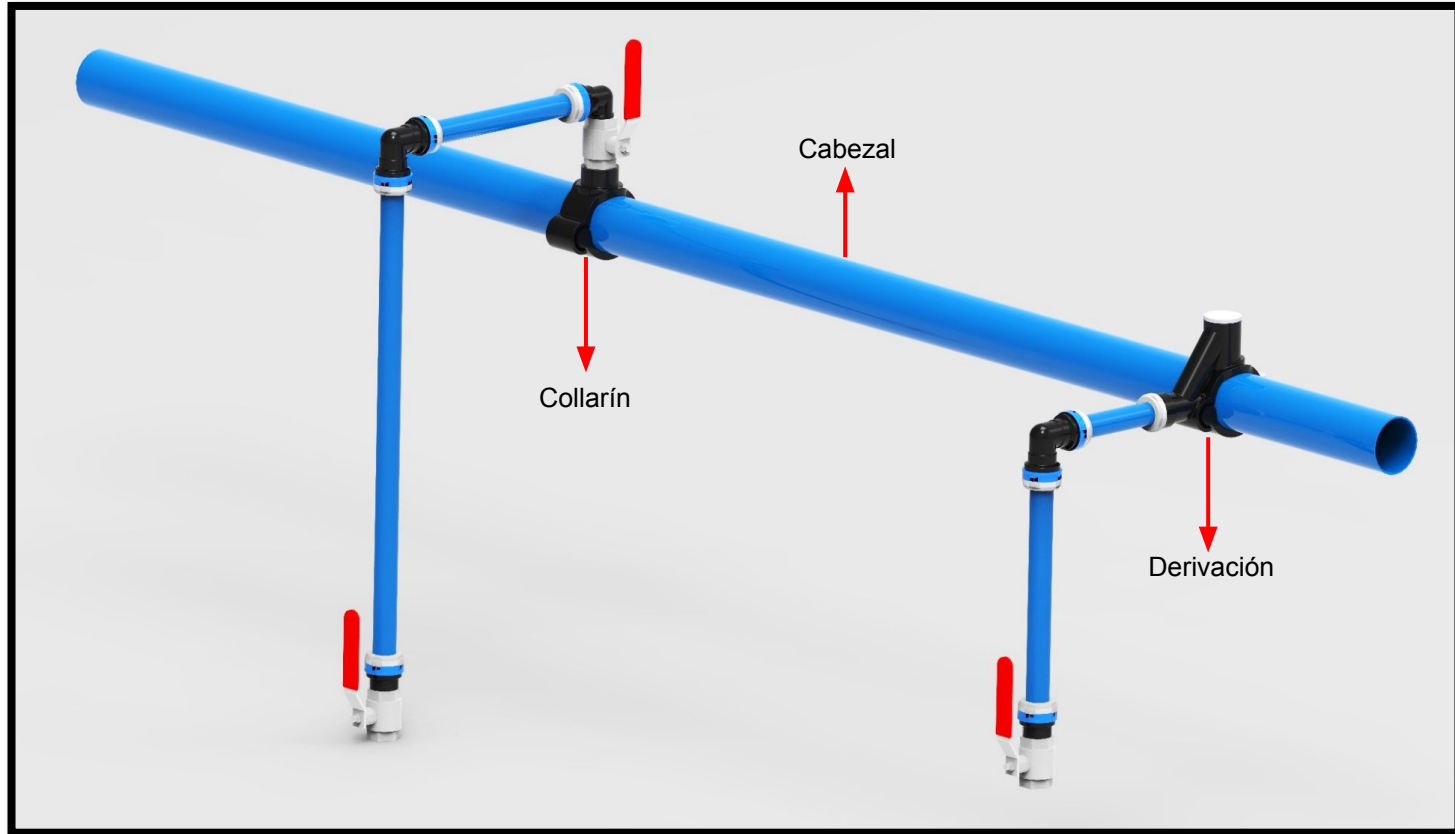

18. Derivaciones y Puntos de uso SmartPipeXL

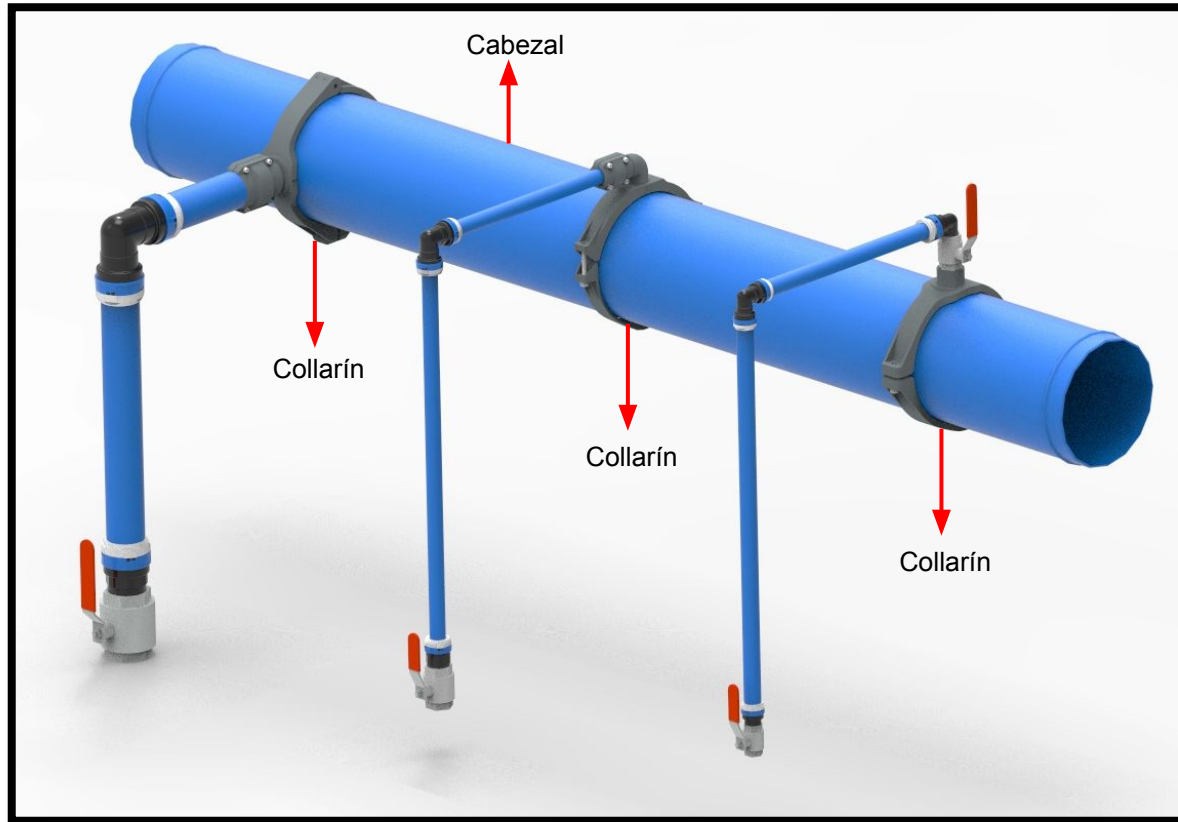

19. Diámetros de broca barril para las derivaciones

()





Accesorio	DN	25	32	40	50	63	75
	Collarín	25mm x 1/2" (9/16)	32mm x 1/2" (9/16)	40mm x 1/2" (9/16)		63mm x 1/2" (9/16)	
	Collarín			40mm x 3/4" (3/4)		63mm x 3/4" (3/4)	
	Collarín					63mm x 1" (15/16)	75mm x 1" (15/16")
	Collarín				50mm x 2" (1-7/8")		75mm x 2" (1-7/8")
	Collarín						
	Derivación	25mm x 20mm (9/16)	32mm x 20mm (9/16)	40mm x 20mm (3/4")	50mm x 20mm (3/4")	63mm x 20mm (3/4)	
	Derivación			40mm x 25mm (3/4")	50mm x 25mm (3/4")	63mm x 25mm (3/4)	

19. Diámetros de broca barril para las derivaciones

()



Accesorios	DN	90	110	160	200	Accesorios DN 200
	Collarín					
	Collarín				200mm x 3/4" (25mm)	
	Collarín	90mm x 1" (15/16")	110mm x 1" (15/16)		200mm x 25mm (25mm)	
	Collarín				200mm x 40mm (51mm)	
	Collarín	90mm x 2" (1-7/8")	110mm x 2" (1 7/8)	160mm x 2" (1-7/8)	200mm x 50mm (51mm)	
	Collarín			160mm x 3" (3-1/8)		

20. Ensamble de las derivaciones

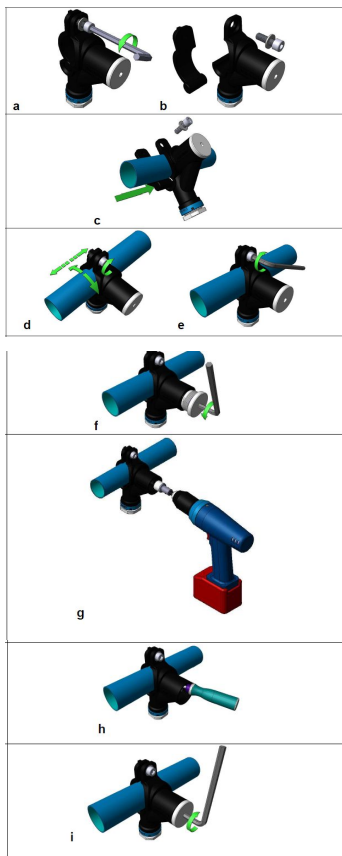

1. Desensamblar accesorio.
2. Colocar en tubo.
3. Nivelar y apretar tornillo.
4. Retirar tapón.
5. Realizar barreno y retirar remanente.
6. Quitar rebaba.
7. Colocar tapón.

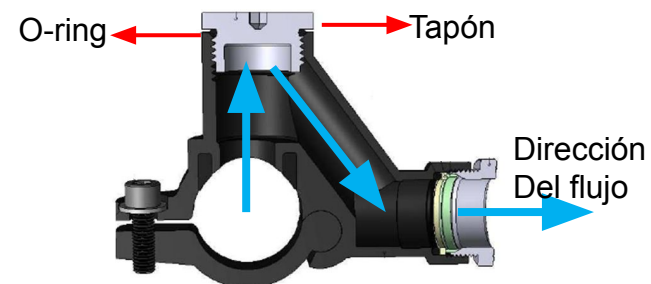

21. Puntos de uso con derivaciones



Vista Isométrica

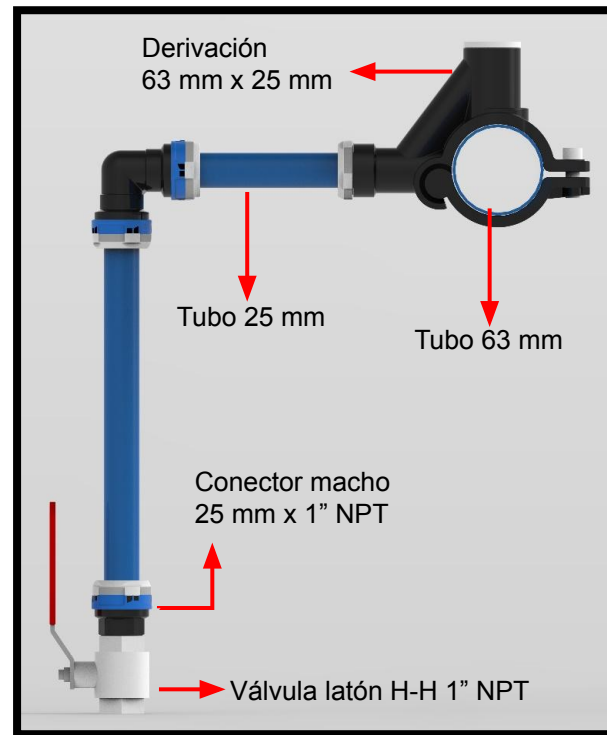

Vista lateral derecha

22. Ensamble de los collarines



1. Retirar tornillo.



2. Desensamblar accesorio.

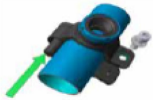

3. Colocar en tubo.



4. Colocar en posición y nivelar.



5. Atornillar.



6. Realizar barreno y retirar remanente.



7. Quitar rebaba.

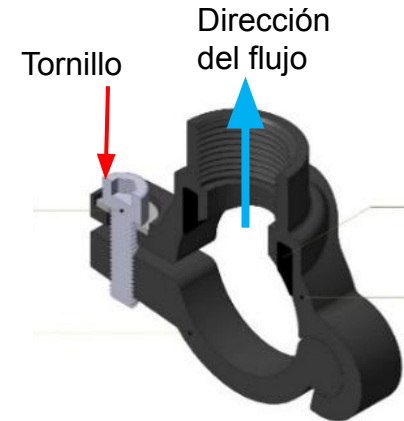

23. Puntos de uso con collarines SmartPipe+



Vista Isométrica

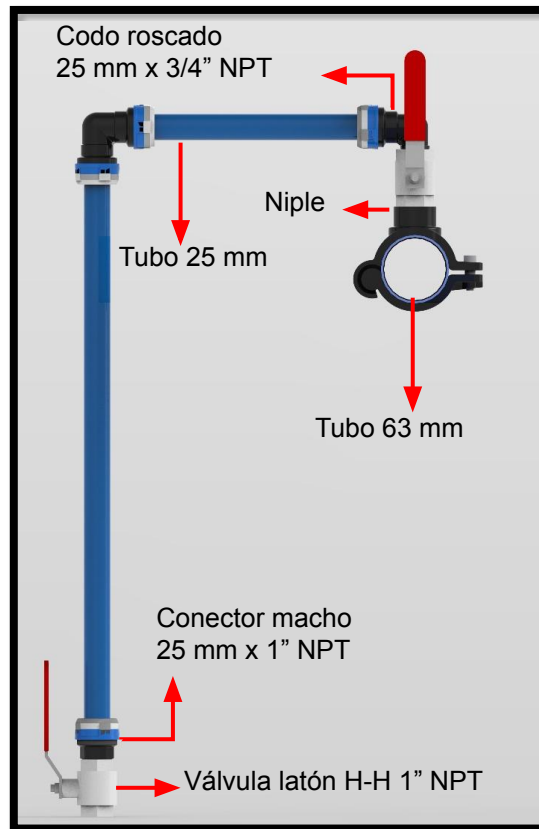

Vista lateral derecha

24. Puntos de uso con collarines SmartPipeXL



Vista Isométrica

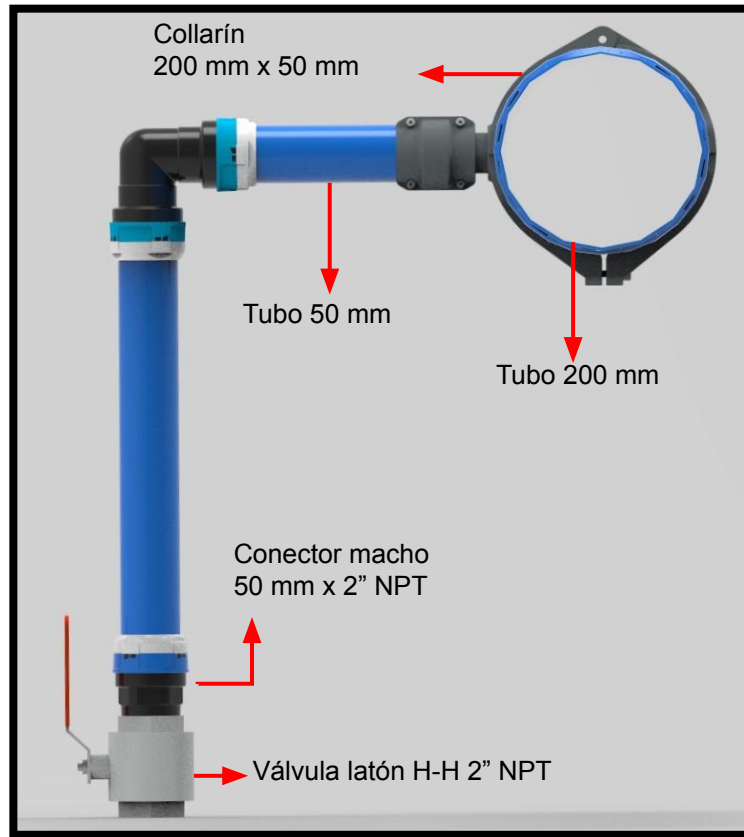

Vista lateral derecha

25. Puntos de uso con collarines SmartPipeXL



Vista Isométrica

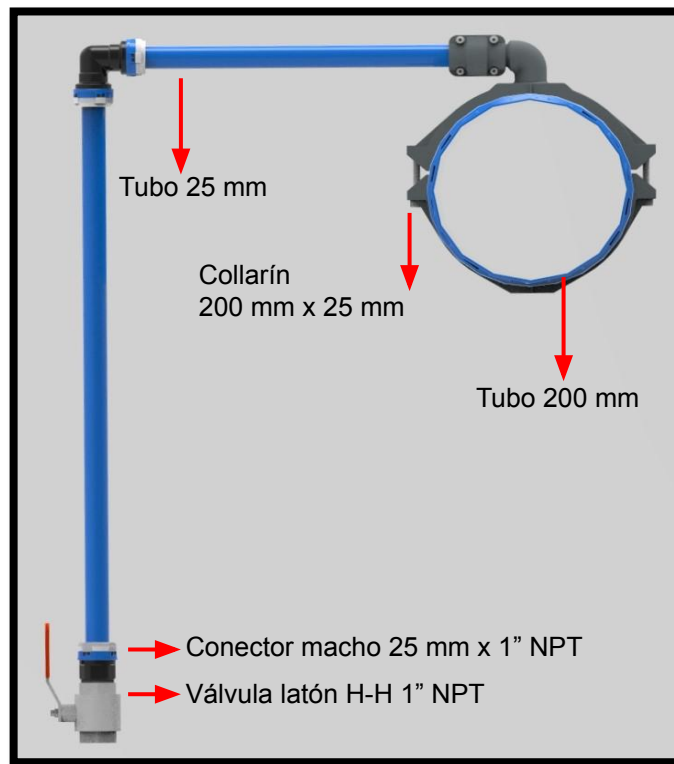

Vista lateral derecha

26. Puntos de uso con collarines SmartPipeXL



Vista Isométrica

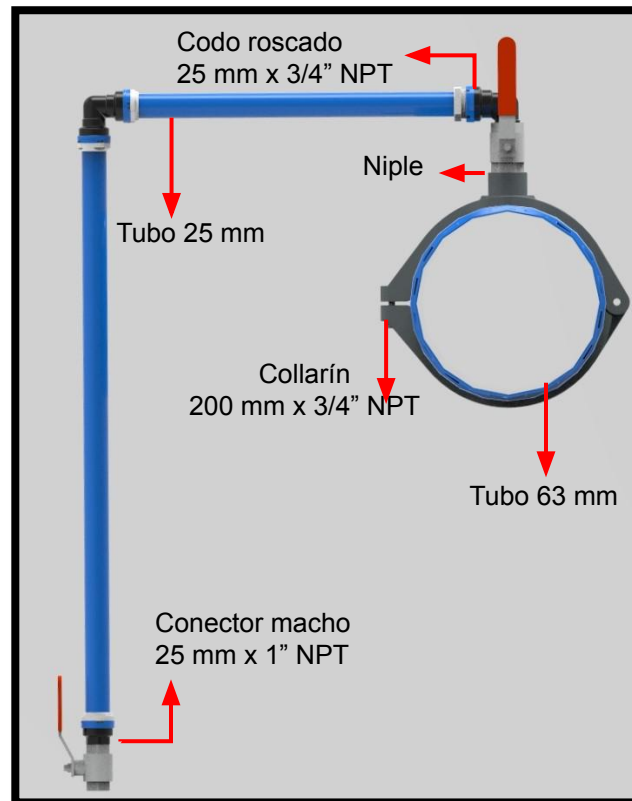

→ Válvula latón H-H 1" NPT

Vista lateral derecha

27. Tapones

27.1 Ensamble

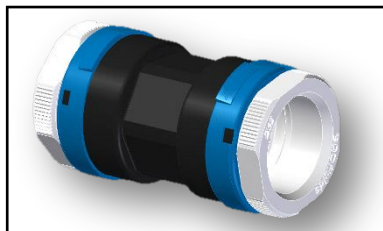

1. Cople ensamblado.



2. Retirar tuerca.

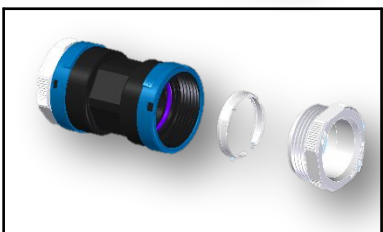

3. Retirar arandela de sujeción.

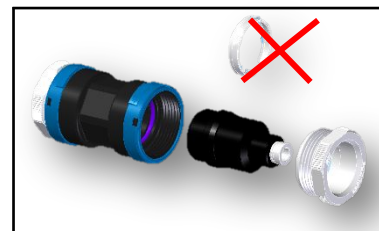

4. Ensamblar tapón.

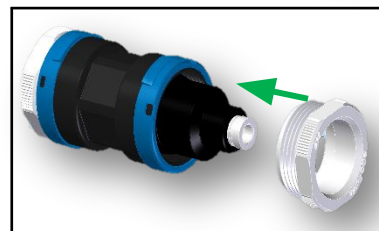

5. Ensamblar tuerca.

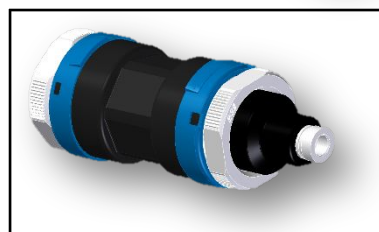

6. Apretar tuerca.

27.2 Desensamble

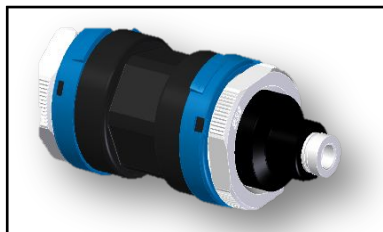

1. Cople ensamblado con tapón.



4. Ensamblar la tuerca.

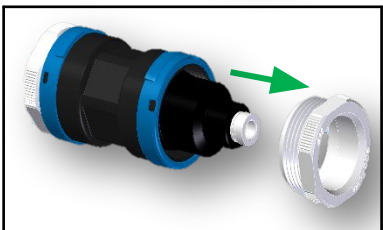

2. Retirar tuerca.

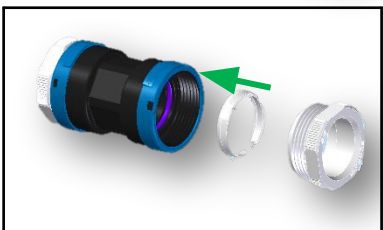

3. Retirar tapón y colocar arandela de sujeción.

28. Abrazaderas

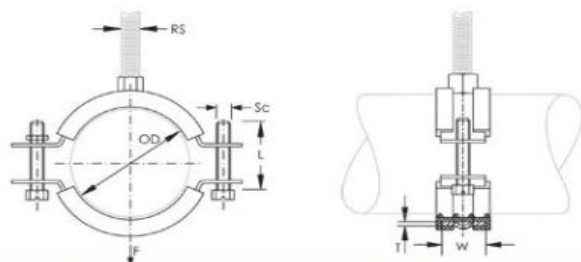

Soporte tipo escalera

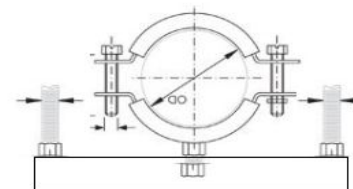

DN (mm)	20	25	32	40	50	63	90	110	160
Tuerca sujeción abrazadera	3/8"								

Abrazadera 2 por cada tubo.

Diámetro de esparrago recomendado.

Altura entre tubo y el techo de la planta (m)	≤ 1.5	> 1.5
Diámetro de esparrago UNC	3/8"	1/2"

Ejemplos instalaciones KAESER

SmartPipe+, SmartPipe+HP y SmartPipeXL

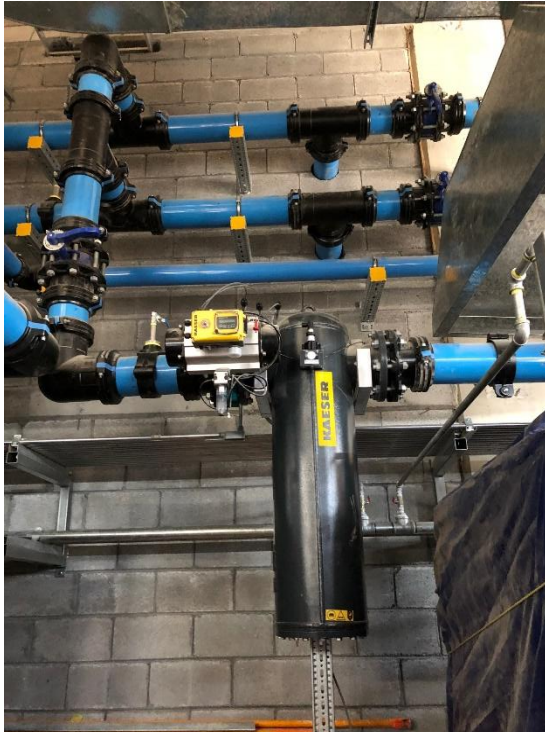

SmartPipe+, SmartPipe+HP y SmartPipeXL



SmartPipe+, SmartPipe+HP y SmartPipeXL

